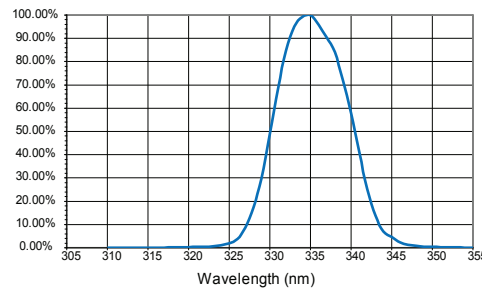

Narrowband 335 nm

System tailored to monitor UV curing systems with an action spectrum of 335 nm.

Order parts# OPM1-D & SED005/NS335/W

**Low-pressure Mercury**

Calibrated at 254 nm to monitor the irradiance output of low-pressure mercury lamps in Watts/cm²

Order parts# OPM1-D & SED008/W

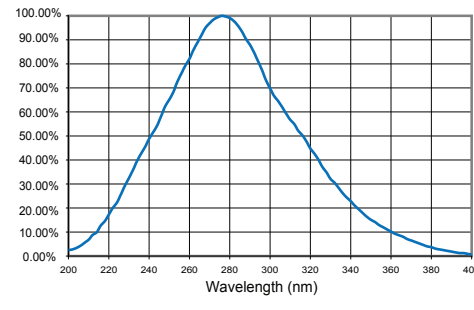
**UVA/Visible**

Configured to monitor the irradiance in Watts/cm² of UVA through blue-visible light sources with output from 320 to 475 nm.

Order part# OPM1-D & XRD340A

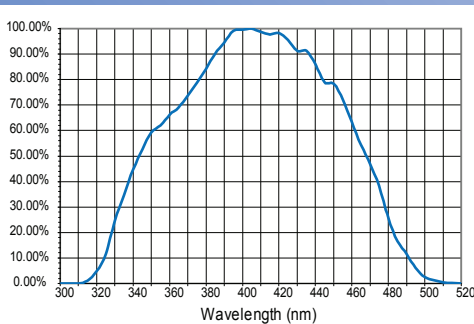
**UVA**

System monitors irradiance in Watts/cm² of almost any UVA source with output from 326 to 401 nm.

Order part# OPM1-D & XRD140B

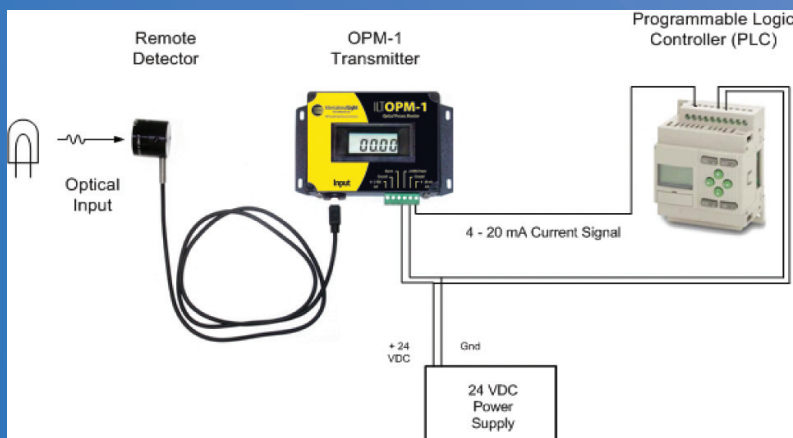
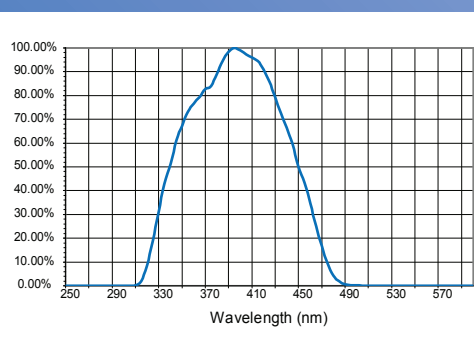

ILTOPM1-D

*Optical Process Monitor
Remote Detector Input Version*



FEATURES & BENEFITS

The ILTOPM Series optical process monitors are designed for on-line monitoring of optical intensities in real-time applications. The remote detector version is configured to accept most of the standard detector / receptor / filter combinations in the ILT line (available separately) to allow greater flexibility in tailoring the ILTOPM1-D system to almost any monitoring application. The sender has a built-in read-out as well as the electrical interface for 4-20 mA operation. The foil-shielded detector cable interfaces with the sender through a 6-pin mini-DIN connector set.

The ILTOPM1-D includes: Operators manual, and NIST traceable calibration. Detector/filter/receptor combinations are available separately. Several common options are shown. Contact sales to configure an ILTOPM1-D system to your unique application.



InternationalLight
TECHNOLOGIES

An ISO 9001 Registered Company

10 Technology Drive
Peabody, MA 01960

978-818-6180

978-818-6181 fax

intl-lighttech.com

Irradiance

ILTOPM1-F

Configured to monitor the irradiance in Watts/cm² of almost any source with output from 400 to 1064 nm.

Order part# OPM1-F

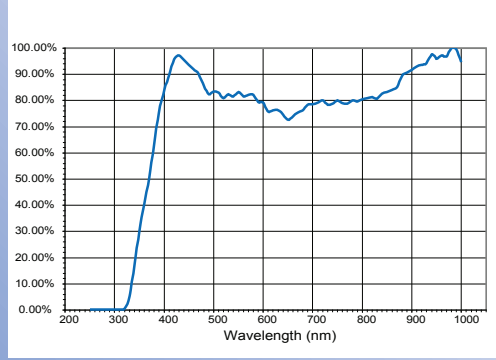

Illuminance

ILTOPM1-Y

Includes our redesigned photopic filter to accurately monitor illuminance of visible light sources. Readout is in foot-candles or Lux (please specify)

Order part# OPM1-Y

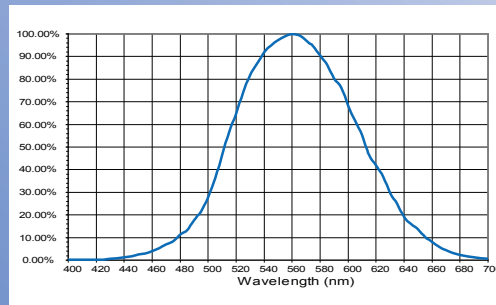

Blue Irradiance

ILTOPM1-BL

Includes a bandpass filter for monitoring the irradiance from blue light sources between 370 and 515 nm. Readout is in Watts/cm².

Order part# OPM1-BL

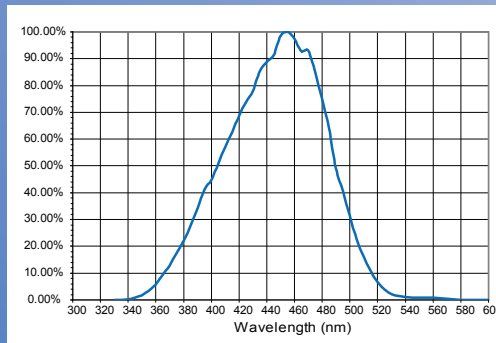

4 - 20 mA Current Loop

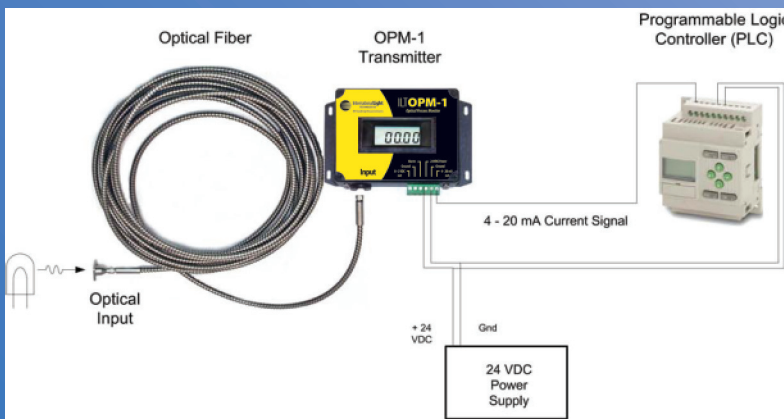

Fiber Mounting Flange

Fiber Optic Input with Mounting Flange/Diffuser

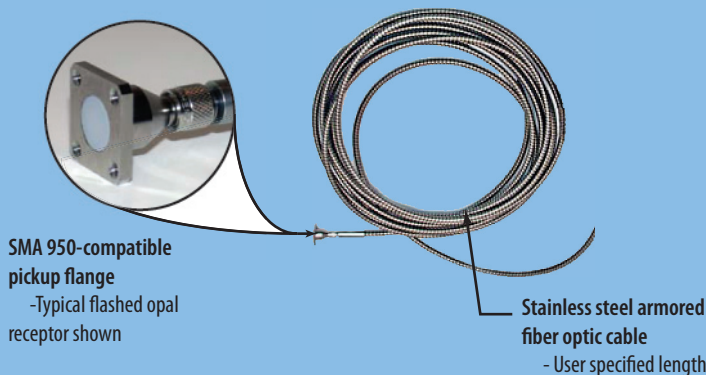

ILTOPM1-F

*Optical Process Monitor
Fiber Optic Input Version*



FEATURES & BENEFITS

The ILTOPM Series optical process monitors are designed for on-line monitoring of optical intensities in real-time applications. The fiber-coupled version is configured with an internally mounted filter and detector allowing the optical pick-up to be placed in environmentally harsh or sensitive environments. Input light is directed onto the fiber surface at the end of the stainless-steel armored cable, and conducted to the remotely-mounted sender. The sender has a built-in read-out as well as the electrical interface for 4-20 mA operation. The remote fiber pick-up can be mounted using the provided SMA 905 adapter flange.

All fiber optic ILTOPM1 models include: ILTOPM1 unit, 2 meter long fiber optic, FL fiber optic mounting flange, flashed opal diffuser, operators manual, and NIST traceable calibration.



InternationalLight
TECHNOLOGIES

An ISO 9001 Registered Company

10 Technology Drive
Peabody, MA 01960

978-818-6180

978-818-6181 fax

intl-lighttech.com